

PM200DV1A120

FLAT-BASE TYPE
INSULATED PACKAGE

PM200DV1A120

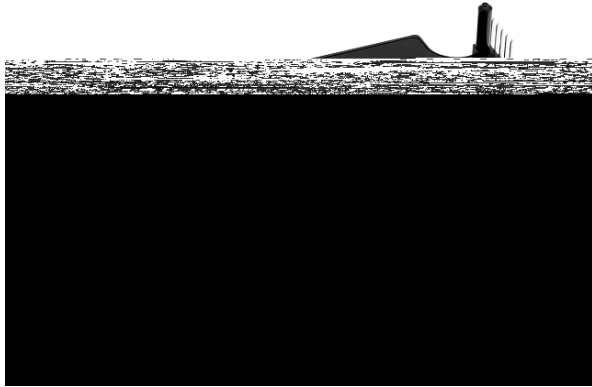

FEATURE

- a) Adopting new 5th generation Full-Gate CSTBT™ chip
 - b) The over-temperature protection which detects the chip surface temperature of CSTBT™ is adopted.
 - c) Error output signal is possible from all each protection upper and lower arm of IPM.
 - d) Compatible V-series package.
- Monolithic gate drive & protection logic
 - Detection, protection & status indication circuits for, short-circuit, over-temperature & under-voltage.

APPLICATION

General purpose inverter, servo drives and other motor controls

PACKAGE OUTLINES

Dimensions in mm

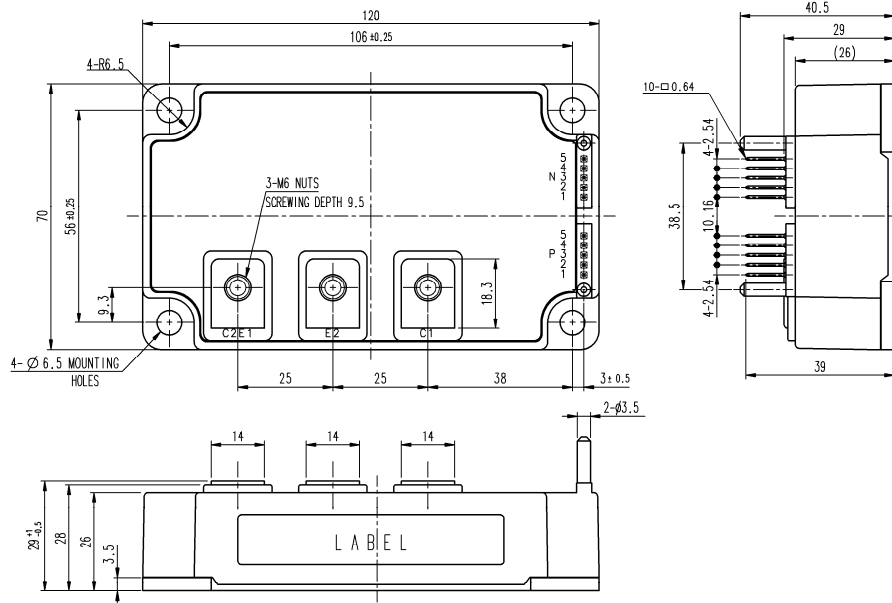

TERMINAL CODE

- | | |
|---|--------|
| | 5: FNO |
| | 4: VNC |
| N | 3: CNI |
| | 2: NC |
| | 1: VN1 |
| | |
| P | 5: FPO |
| | 4: VPC |
| | 3: CPI |
| | 2: NC |
| | 1: VP1 |

PM200DV1A120

FLAT-BASE TYPE
INSULATED PACKAGE

INTERNAL FUNCTIONS BLOCK DIAGRAM

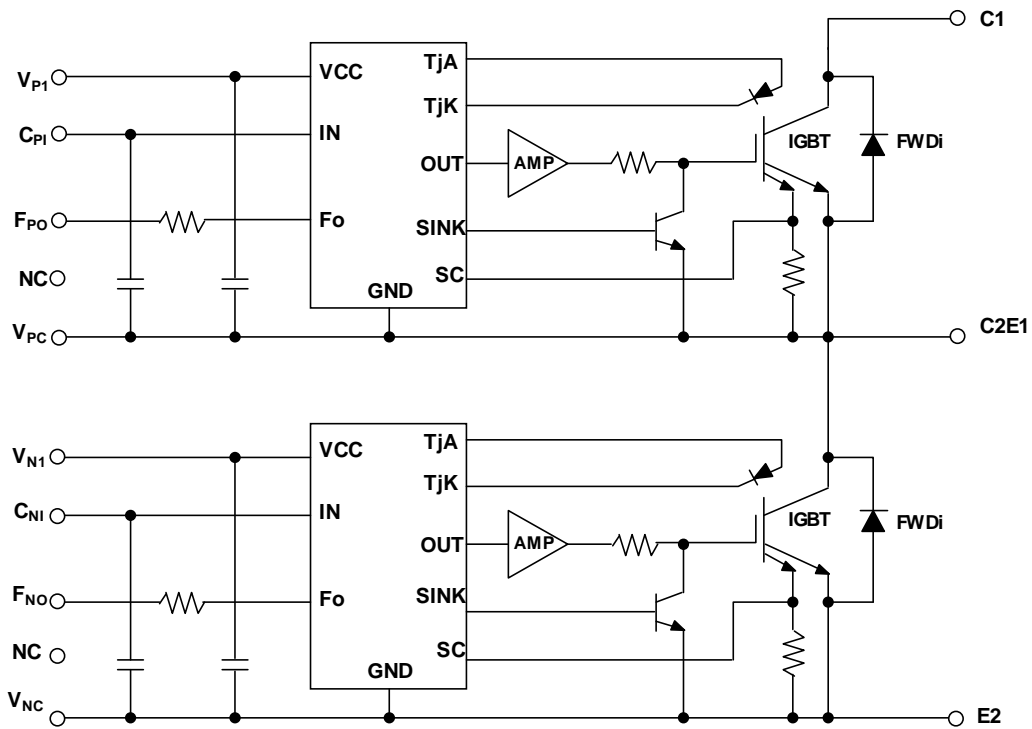

MAXIMUM RATINGS (T_j = 25°C, unless otherwise noted)

INVERTER PART

Symbol	Parameter	Conditions	Ratings	Unit
V _{CES}	Collector-Emitter Voltage	V _D =15V, V _{CIN} =15V	1200	V
I _C	Collector Current	T _C =25°C	200	A
I _{CRM}		Pulse	400	
P _{tot}	Total Power Dissipation	T _C =25°C	1388	W
I _E	Emitter Current (Free wheeling Diode Forward current)	T _C =25°C	200	A
I _{ERM}		Pulse	400	
T _J	Junction Temperature		-20 ~ +150	°C

*: T_C measurement point is just under the chip.

CONTROL PART

Symbol	Parameter	Conditions	Ratings	Unit
V _D	Supply Voltage	Applied between : V _{P1} -V _{PC} , V _{N1} -V _{NC}	20	V
V _{CIN}	Input Voltage	Applied between : C _{PI} -V _{PC} , C _{NI} -V _{NC}	20	V
V _{FO}	Fault Output Supply Voltage	Applied between : F _{PO} -V _{PC} , F _{NO} -V _{NC}	20	V
I _{FO}	Fault Output Current	Sink current at F _{PO} , F _{NO} terminals	20	mA

PM200DV1A120

**FLAT-BASE TYPE
INSULATED PACKAGE**

TOTAL SYSTEM

Symbol	Parameter	Conditions	Ratings	Unit
$V_{CC(prot)}$	Supply Voltage Protected by SC	$V_D = 13.5V \sim 16.5V$ Inverter Part, $T_j = +125^\circ C$ Start	800	V
$V_{CC(surge)}$	Supply Voltage (Surge)	Applied between : C1-E2, Surge value	1000	V
T_C	Module case operating temperature		-20 ~ +100	$^\circ C$
T_{stg}	Storage Temperature		-40 ~ +125	$^\circ C$
V_{isol}	Isolation Voltage	60Hz, Sinusoidal, Charged part to Base, AC 1min.	2500	V_{rms}

*: T_C measurement point is just under the chip.

THERMAL RESISTANCE

Symbol	Parameter	Conditions	Limits			Unit
			Min.	Typ.	Max.	
$R_{th(j-c)Q}$	Thermal Resistance	Junction to case, IGBT (per 1 element) (Note.1)	-	-	0.09	K/W
$R_{th(j-c)D}$		Junction to case, FWDi (per 1 element) (Note.1)	-	-	0.146	
$R_{th(c-s)}$	Contact Thermal Resistance	Case to heat sink, (per 1 module) Thermal grease applied (Note.1)	-	0.018	-	

Note.1: If you use this value, $R_{th(s-a)}$ should be measured just under the chips.

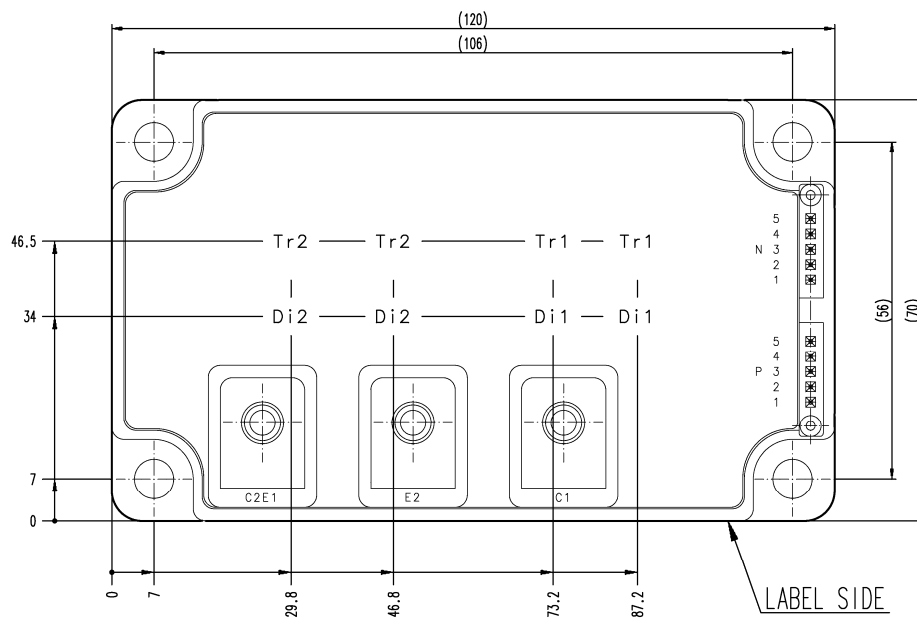

ELECTRICAL CHARACTERISTICS ($T_j = 25^\circ C$, unless otherwise noted)

INVERTER PART

Symbol	Parameter	Conditions	Limits			Unit
			Min.	Typ.	Max.	
V_{CEsat}	Collector-Emitter Saturation Voltage	$V_D = 15V, I_C = 200A$ $V_{CIN} = 0V$, Pulsed (Fig. 1)	$T_j = 25^\circ C$ -	1.65	2.15	V
V_{EC}	Emitter-Collector Voltage	$I_E = 200A, V_D = 15V, V_{CIN} = 15V$ (Fig. 2)	-	2.3	3.3	V
t_{on}	Switching Time	$V_D = 15V, V_{CIN} = 0V$ 15V $V_{CC} = 600V, I_C = 200A$ $T_j = 125^\circ C$ Inductive Load (Fig. 3,4)	0.3	0.8	2.0	μs
t_{rr}			-	0.3	0.8	
$t_{c(on)}$			-	0.4	1.0	
t_{off}			-	2.4	3.3	
$t_{c(off)}$			-	0.4	1.2	
I_{CES}	Collector-Emitter Cut-off Current	$V_{CE} = V_{CES}, V_D = 15V, V_{CIN} = 15V$ (Fig. 5)	$T_j = 25^\circ C$ -	-	1	mA
			$T_j = 125^\circ C$ -	-	10	

PM200DV1A120

**FLAT-BASE TYPE
INSULATED PACKAGE**

CONTROL PART

Symbol	Parameter	Conditions	Limits			Unit	
			Min.	Typ.	Max.		
I _D	Circuit Current	V _D =15V, V _{CIN} =15V	V _{P1} -V _{PC}	-	2	4	mA
			V _{N1} -V _{NC}	-	2	4	
V _{th(ON)}	Input ON Threshold Voltage	Applied between : C _{P1} -V _{PC} , C _{N1} -V _{NC}	1.2	1.5	1.8	V	
V _{th(OFF)}	Input OFF Threshold Voltage		1.7	2.0	2.3		
SC	Short Circuit Trip Level	-20 T _J 125°C, V _D =15V (Fig. 3, 6)	300	-	-	A	
t _{off(SC)}	Short Circuit Current Delay Time	V _D =15V (Fig. 3, 6)	-	0.2	-	μs	
OT	Over Temperature Protection	Detect Temperature of IGBT chip	Trip level	135	-	-	°C
OT _(hys)			Hysteresis	-	20	-	
UV _t	Supply Circuit Under-Voltage Protection	-20 T _J 125°C	Trip level	11.5	12.0	12.5	V
UV _r			Reset level	-	12.5	-	
I _{FO(H)}	Fault Output Current	V _D =15V, V _{FO} =15V (Note.2)	-	-	0.01	mA	
I _{FO(L)}			-	10	15		
t _{FO}	Fault Output Pulse Width	V _D =15V (Note.2)	1.0	1.8	-	ms	

Note.2: Fault output is given only when the internal SC, OT & UV protections schemes of either upper or lower arm device operate to protect it.

MECHANICAL RATINGS AND CHARACTERISTICS

Symbol	Parameter	Conditions	Limits			Unit
			Min.	Typ.	Max.	
M _t		Mounting part screw : M6	3.92	4.90	5.88	

PM200DV1A120

FLAT-BASE TYPE
INSULATED PACKAGE

PRECAUTIONS FOR TESTING

1. Before applying any control supply voltage (V_D), the input terminals should be pulled up by resistors, etc. to their corresponding supply voltage and each input signal should be kept off state.
After this, the specified ON and OFF level setting for each input signal should be done.
2. When performing "SC" tests, the turn-off surge voltage spike at the corresponding protection operation should not be allowed to rise above V_{CES} rating of the device.
(These test should not be done by using a curve tracer or its equivalent.)

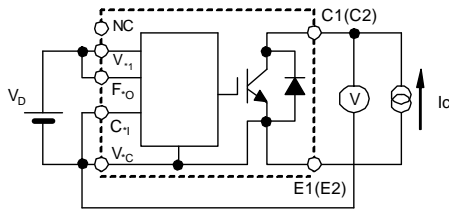

Fig. 1 V_{CEsat} Test

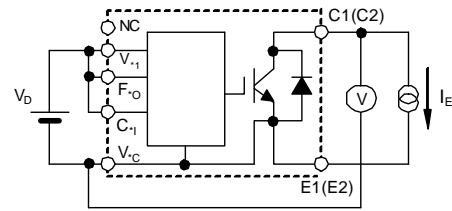

Fig. 2 V_{EC} Test

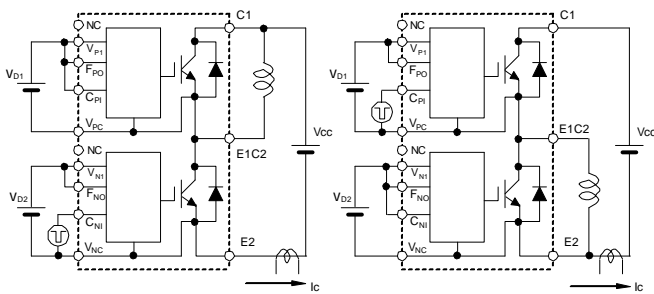

Fig. 3 Switching time and SC test circuit

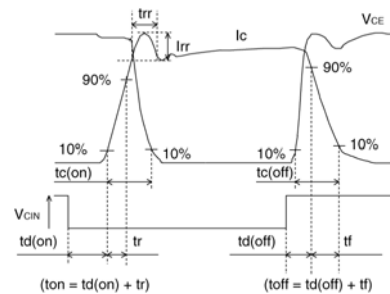

Fig. 4 Switching time test waveform

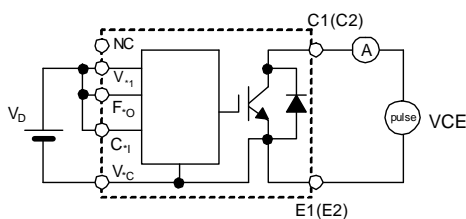

Fig. 5 I_{CES} Test

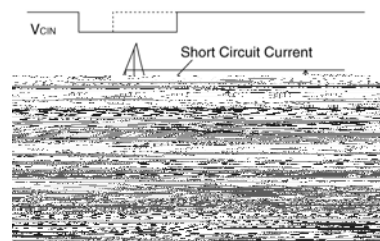
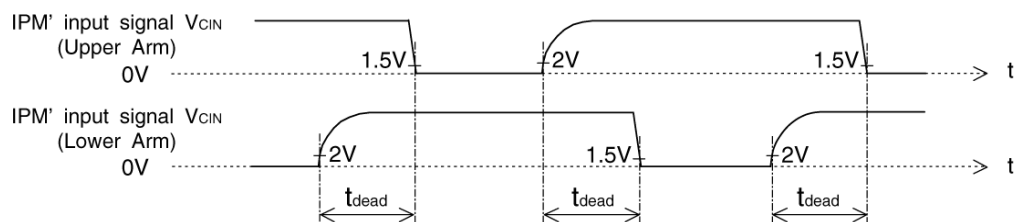

Fig. 6 SC test waveform



1.5V: Input on threshold voltage $V_{th(on)}$ typical value, 2V: Input off threshold voltage $V_{th(off)}$ typical value

Fig. 7 Dead time measurement point example



Fig. 8 Application Example Circuit

NOTES FOR STABLE AND SAFE OPERATION ;

- Design the PCB pattern to minimize wiring length between opto-coupler and IPM's input terminal, and also to minimize the stray capacity between the input and output wirings of opto-coupler.
- Connect low impedance capacitor between the Vcc and GND terminal of each fast switching opto-coupler.
- Fast switching opto-couplers: t_{PLH} , t_{PHL} 0.8 μ s, Use High CMR type.
- Slow switching opto-coupler: CTR > 100%
- Use 6 isolated control power supplies (V_D). Also, care should be taken to minimize the instantaneous voltage charge of the power supply.
- Make inductance of DC bus line as small as possible, and minimize surge voltage using snubber capacitor between C1 and E2 terminal.

PM200DV1A120

FLAT-BASE TYPE
INSULATED PACKAGE

PERFORMANCE CURVES

OUTPUT CHARACTERISTICS (TYPICAL)

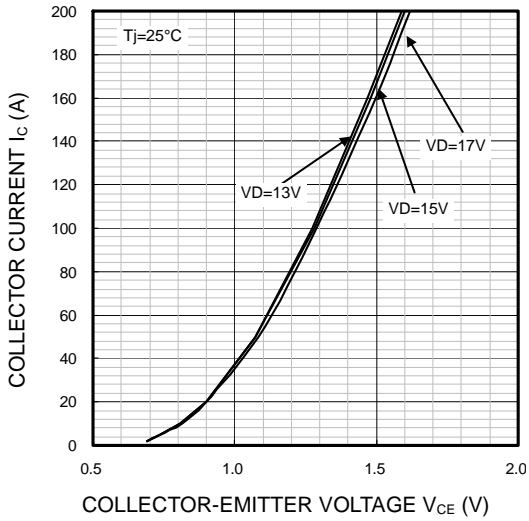

COLLECTOR-EMITTER SATURATION VOLTAGE (VS. I_c) CHARACTERISTICS (TYPICAL)

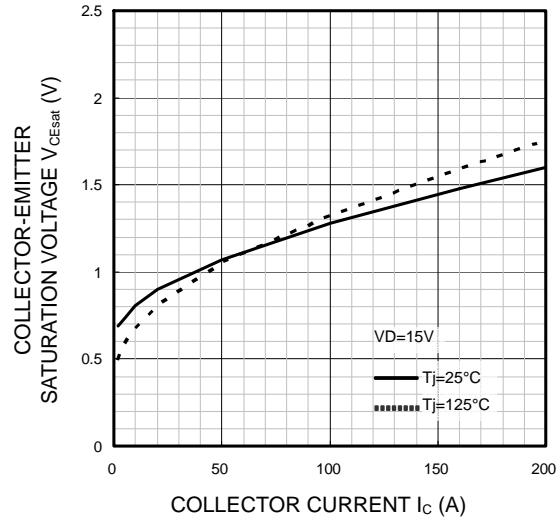

COLLECTOR-EMITTER SATURATION VOLTAGE (VS. V_D) CHARACTERISTICS (TYPICAL)

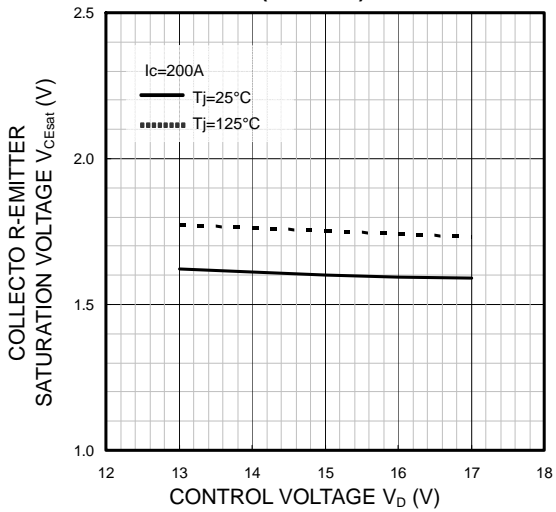

FREE WHEELING DIODE FORWARD CHARACTERISTICS (TYPICAL)

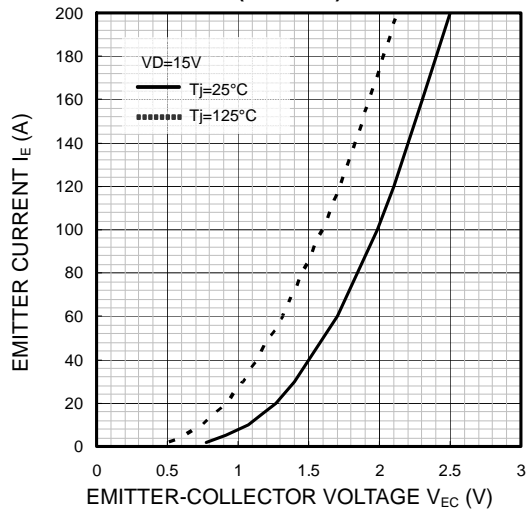

PM200DV1A120

FLAT-BASE TYPE
INSULATED PACKAGE

SWITCHING TIME (t_{on} , t_{off}) CHARACTERISTICS
(TYPICAL)

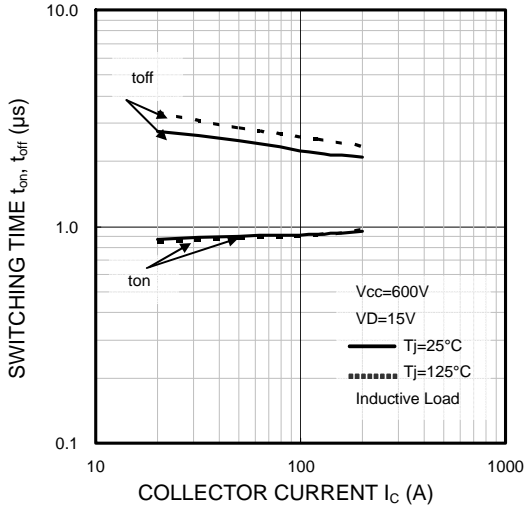

SWITCHING TIME ($t_{c(on)}$, $t_{c(off)}$) CHARACTERISTICS
(TYPICAL)

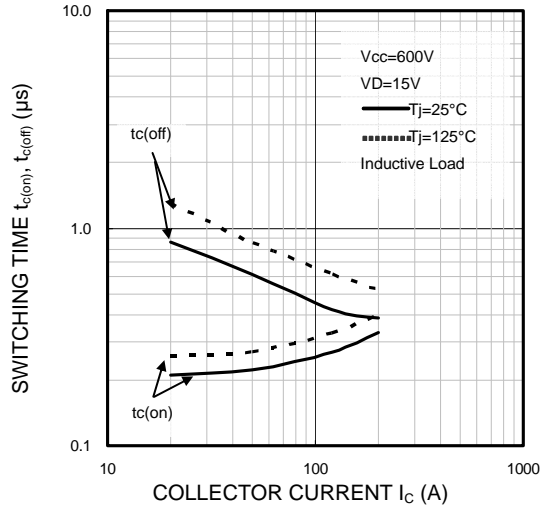

SWITCHING ENERGY CHARACTERISTICS
(TYPICAL)

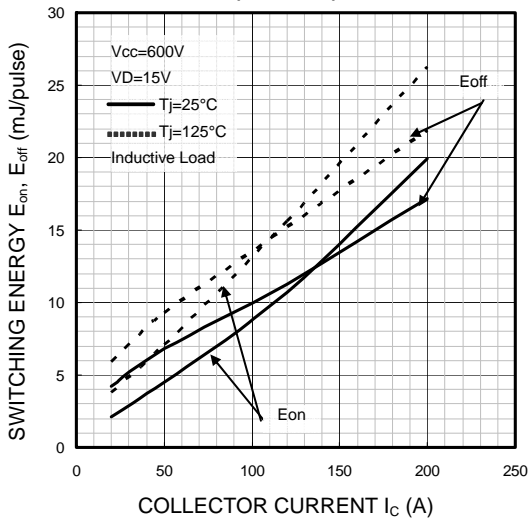

FREE WHEELING DIODE
REVERSE RECOVERY CHARACTERISTICS
(TYPICAL)

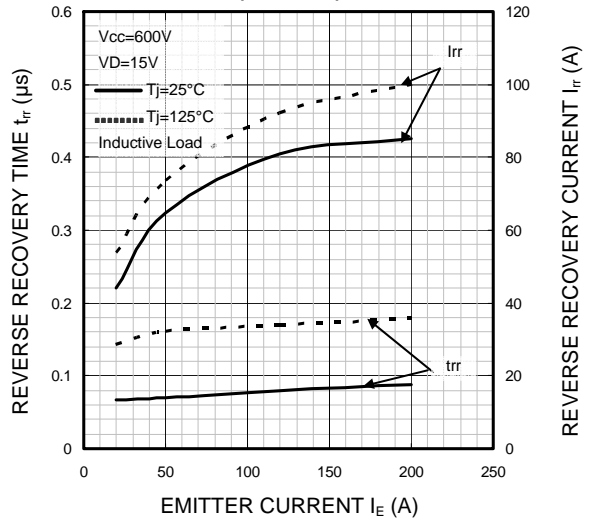

FREE WHEELING DIODE
REVERSE RECOVERY ENERGY CHARACTERISTICS
(TYPICAL)

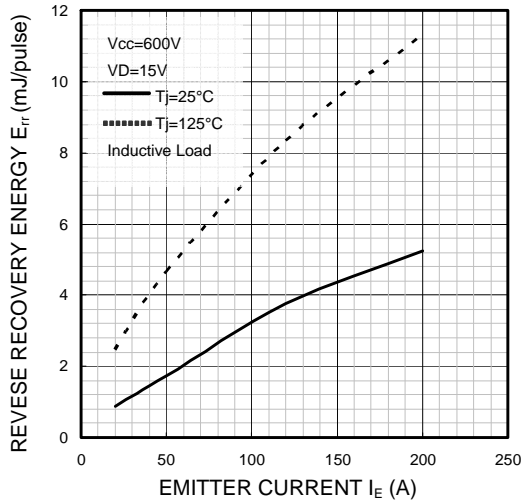

I_D VS. f_c CHARACTERISTICS
(TYPICAL)

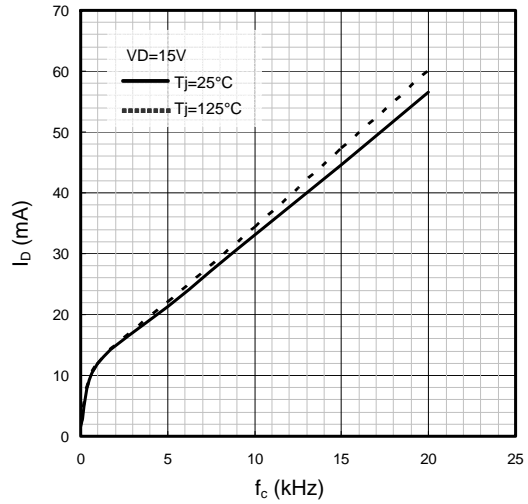

UV TRIP LEVEL VS. T_j CHARACTERISTICS
(TYPICAL)

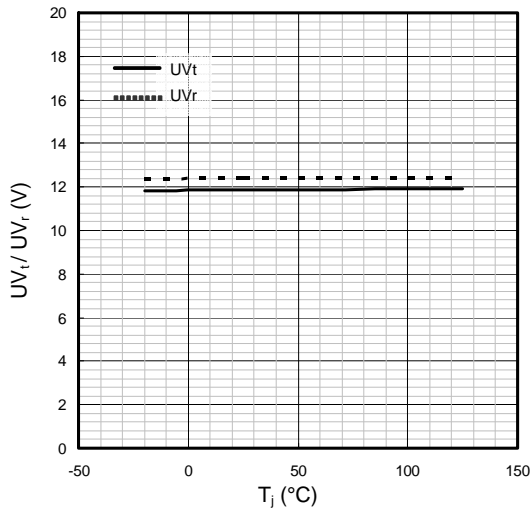

SC TRIP LEVEL VS. T_j CHARACTERISTICS
(TYPICAL)

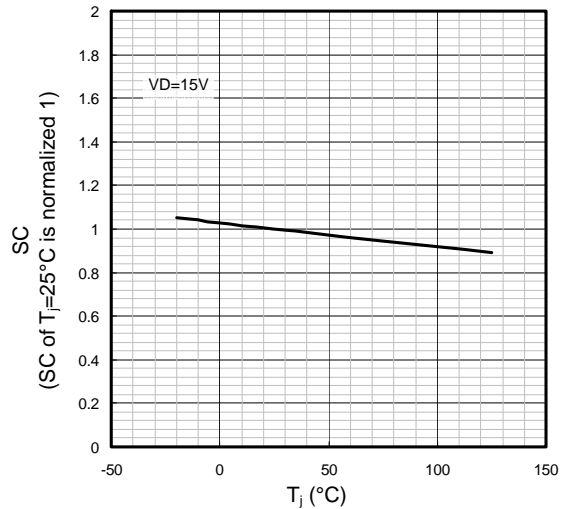

PM200DV1A120

FLAT-BASE TYPE
INSULATED PACKAGE

